

LB2317

Ikdienas tīrīšanas norādes

LAVAZZA

TORINO ITALIA 1895

BRĪDINĀJUMS: Dubultā kafijas tekne nav noņemama. Nevelciet to un nemēģiniet izstiept.

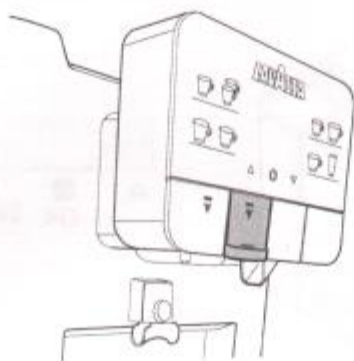

Pēc katras piena padeves

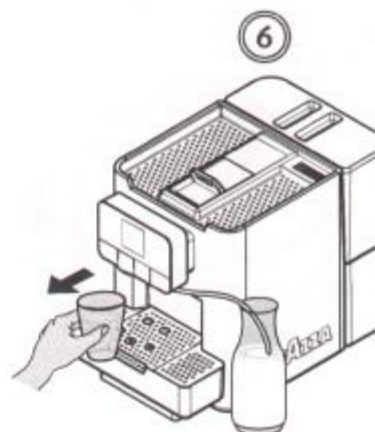
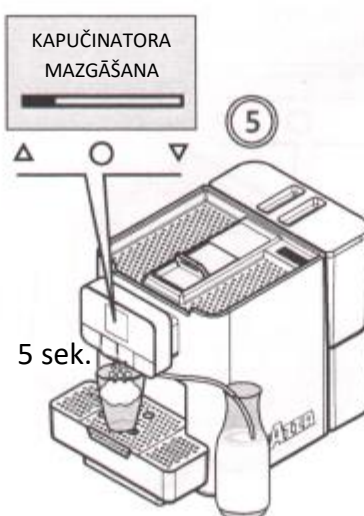
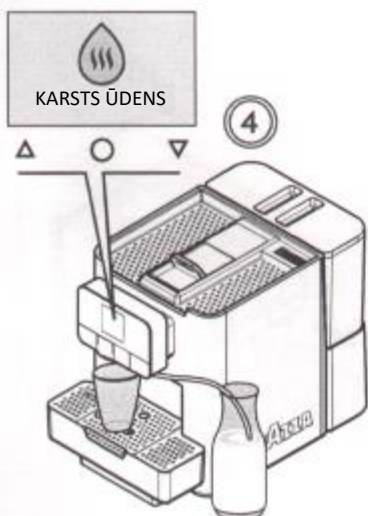
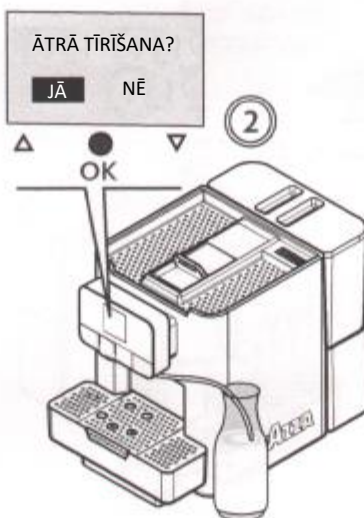
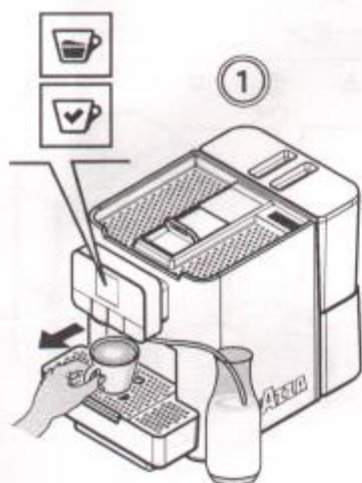

LB2317

Ikdienas tīrīšanas norādes

LAVAZZA

TORINO ITALIA 1895

Piena moduļa padziļināta tīrīšana (vienu reizi dienā)

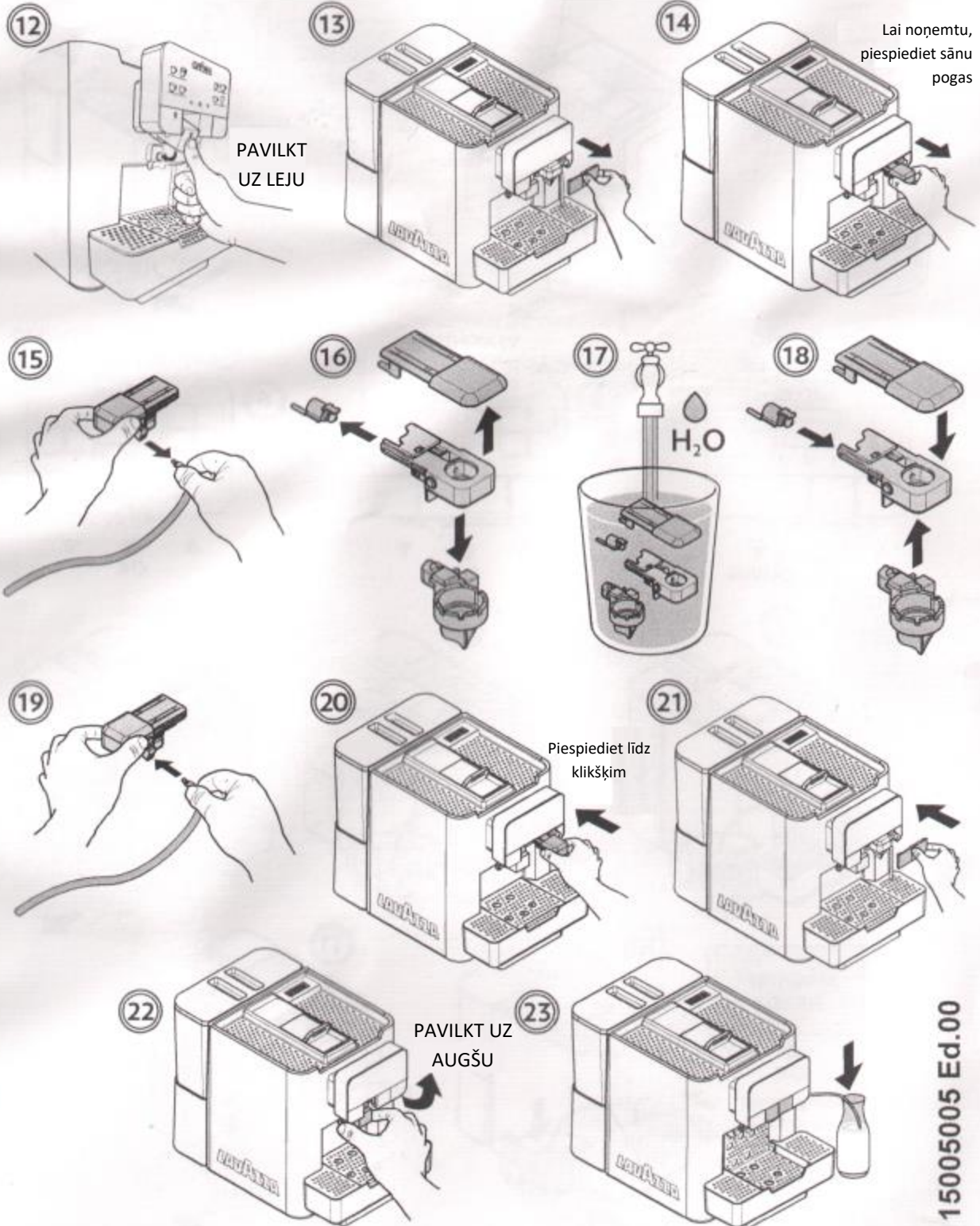

15005005 Ed.00

LB2317

Ikdienas tīrīšanas norādes

LAVAZZA

TORINO ITALIA 1895

Piena moduļa padziļināta tīrīšana (vienu reizi dienā)

1



DOZATORA
MAZGĀŠANA

2

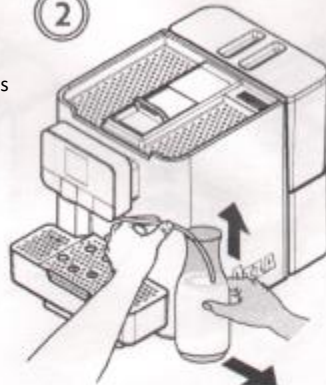

KAPUČINATORA
MAZGĀŠANA

3

IEKĀRTA GATAVA
DARBAM

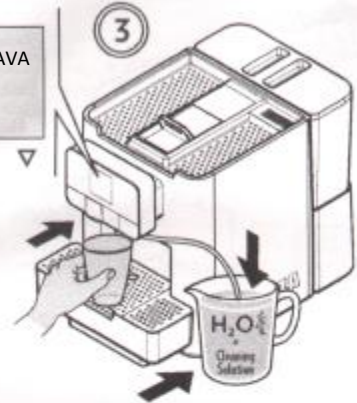

PILNA KAPUČINATORA
MAZGĀŠANA

4



UZ LEJU

5

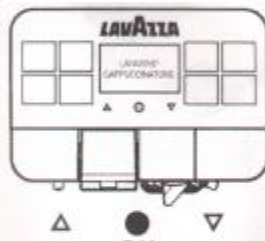

OK

6



OK

MAZGĀŠANA

7

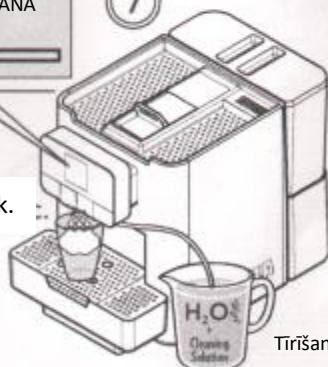

5 sek.

Tīrīšanas šķīdums

8

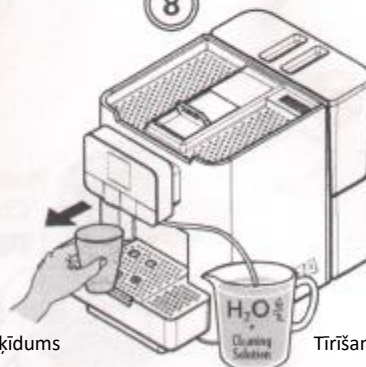

Tīrīšanas šķīdums

9

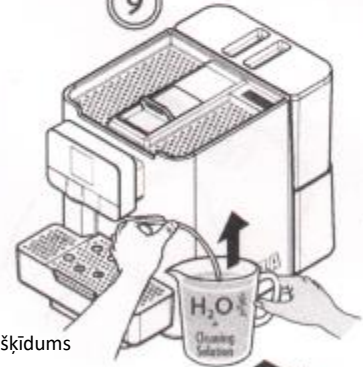

Tīrīšanas šķīdums

IEKĀRTA GATAVA
DARBAM

OK

Skalošanai atkārtot
soļus 4-5-6-7

10

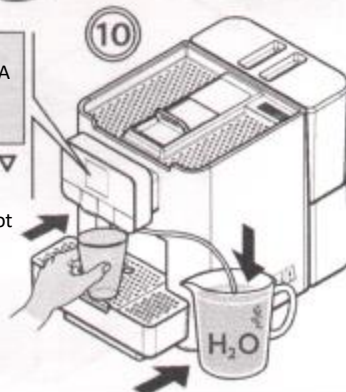

11

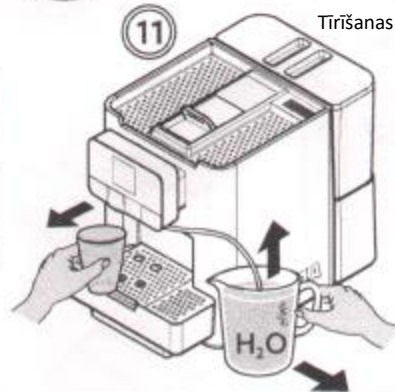

LB2317

Ikdienas tīrīšanas norādes

LAVAZZA

TORINO ITALIA 1895

Piena moduļa ātrā tīrīšana

